

MEM-PF-5' ISLAND_INSTRUCTIONS

- LW01
- B01
- ST02
- BTT25

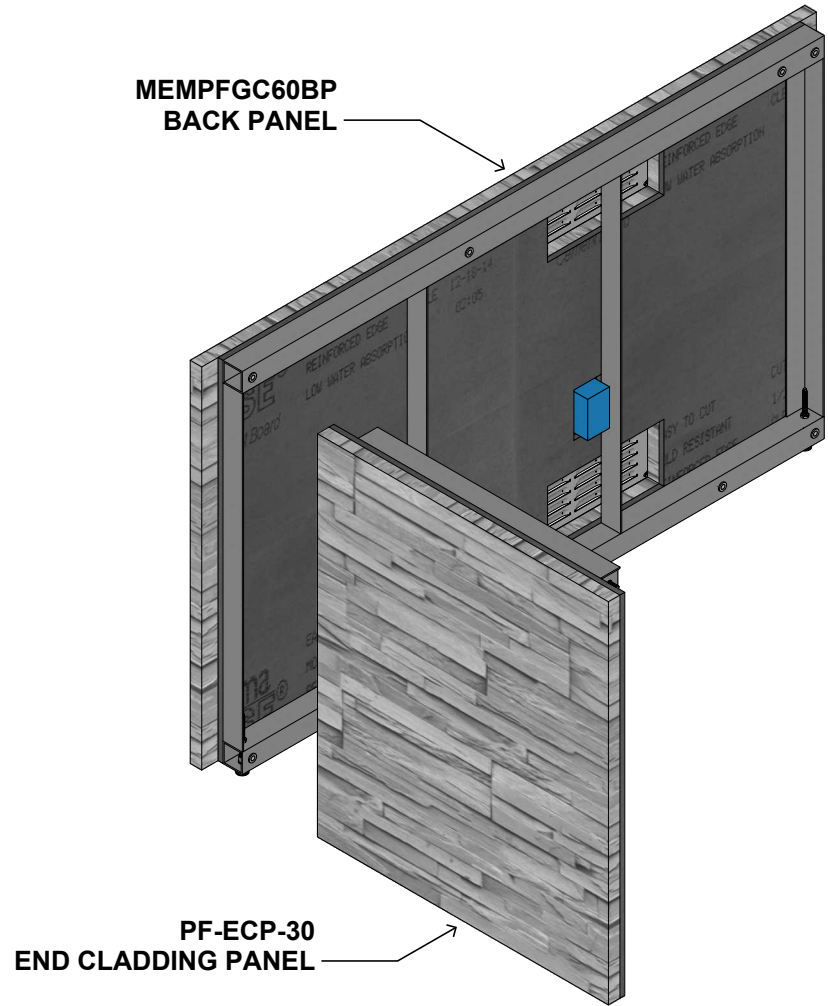

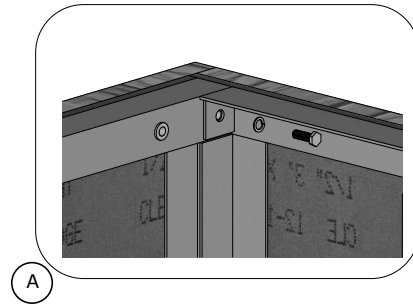

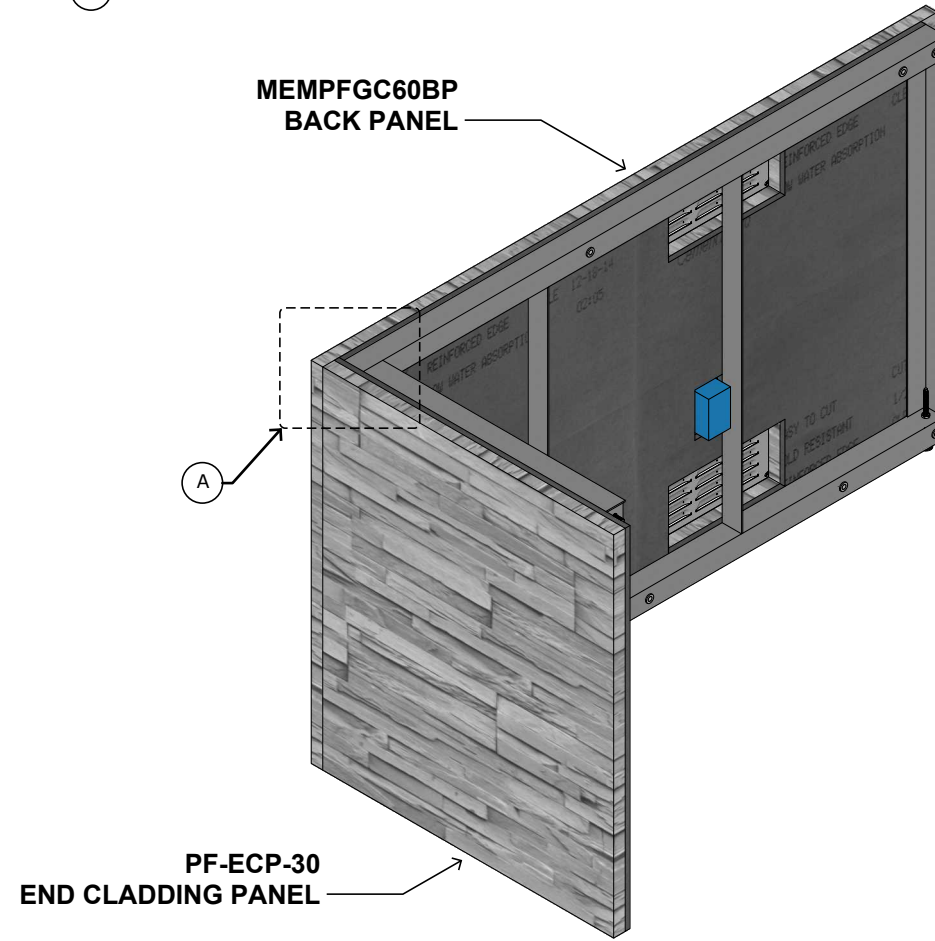

STEP 1
Scale: NTS



STEP 2
Scale: NTS

MEM-PF-5' ISLAND_INSTRUCTIONS

-  LW01
-  B01
-  ST02
-  BTT25

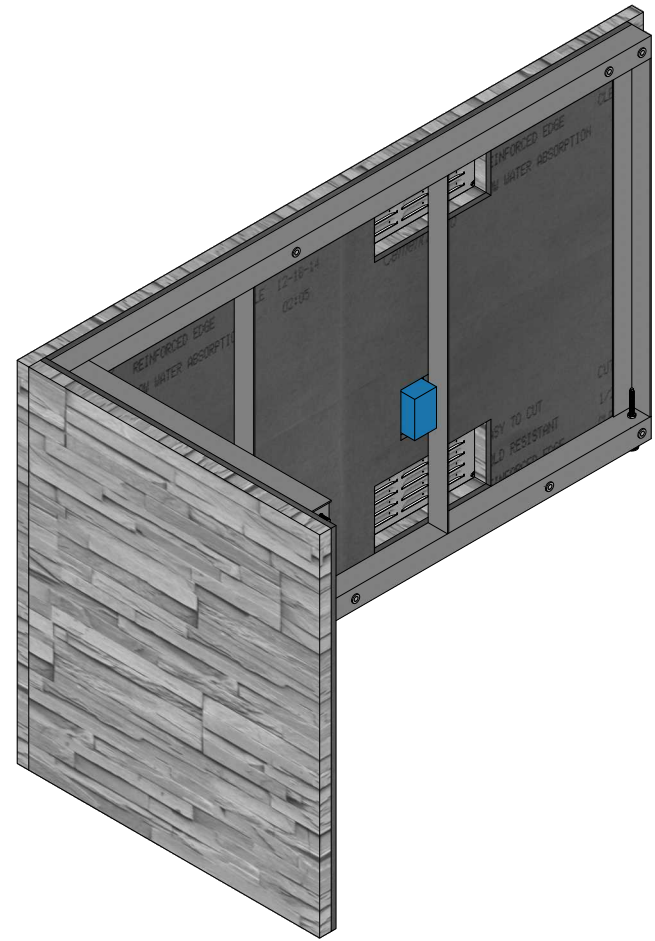

STEP 3
Scale: NTS

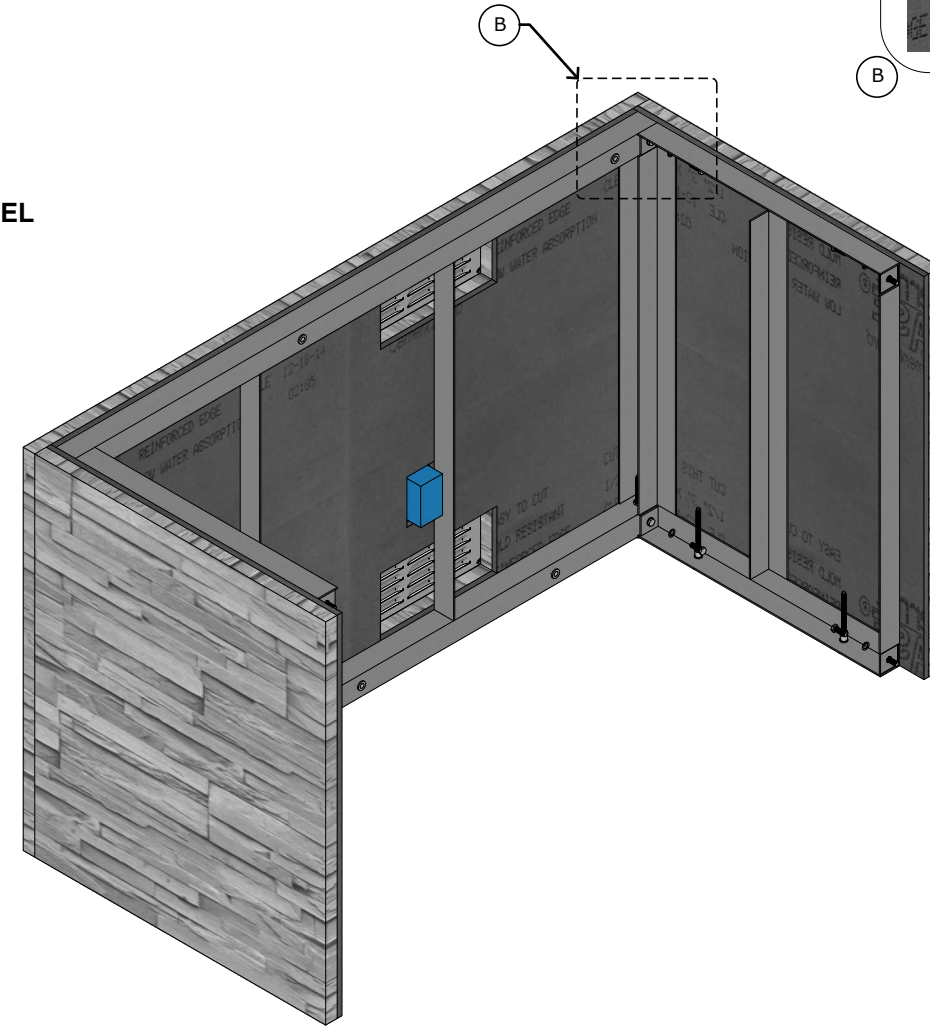
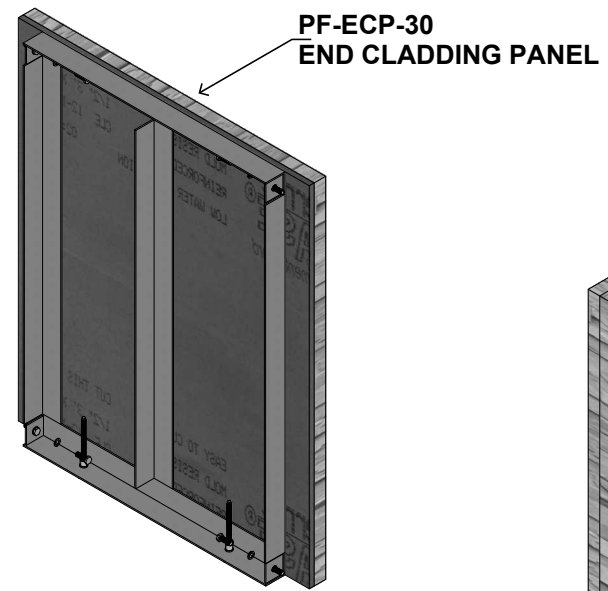

STEP 4
Scale: NTS

MEM-PF-5' ISLAND_INSTRUCTIONS

- LW01
- B01
- ST02
- BTT25

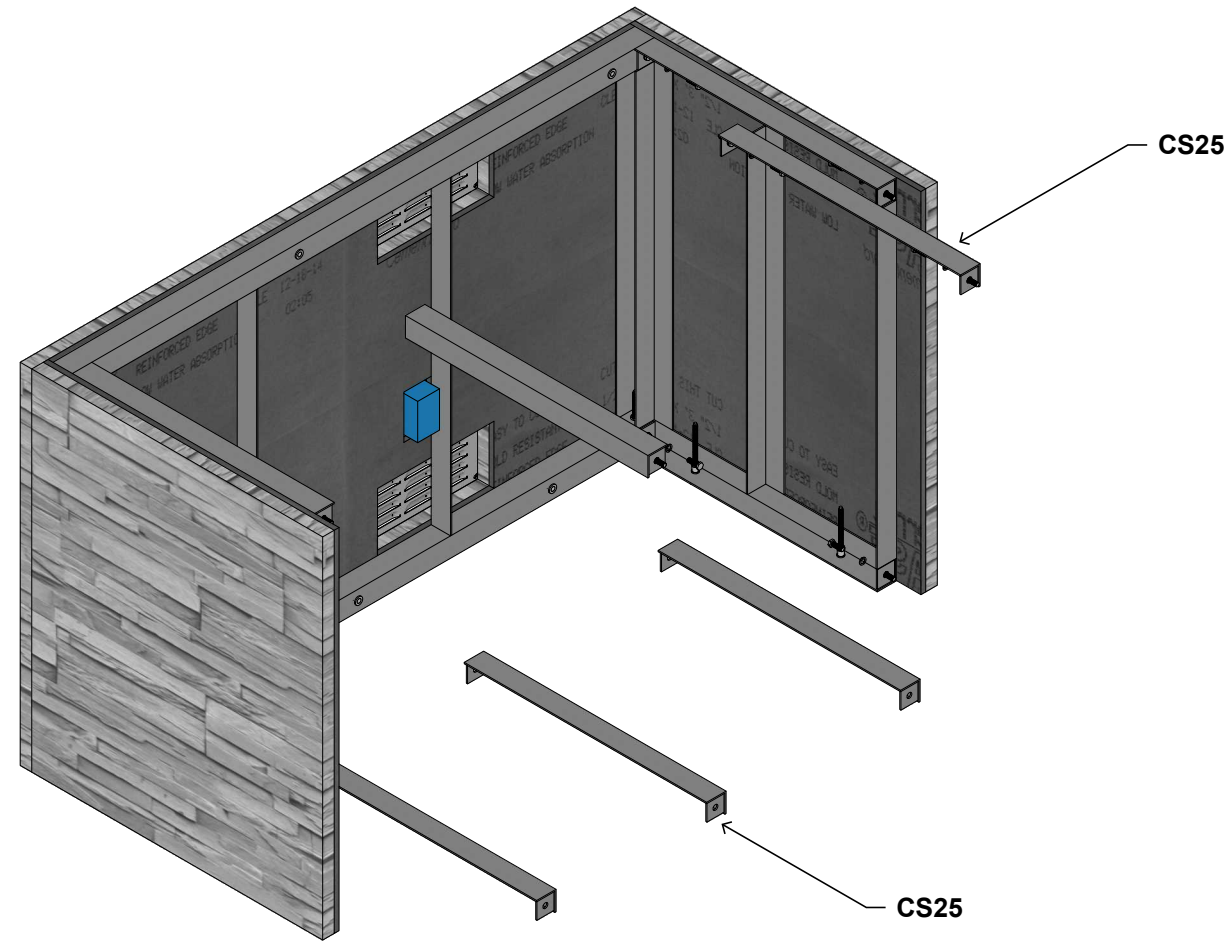

STEP 5
Scale: NTS

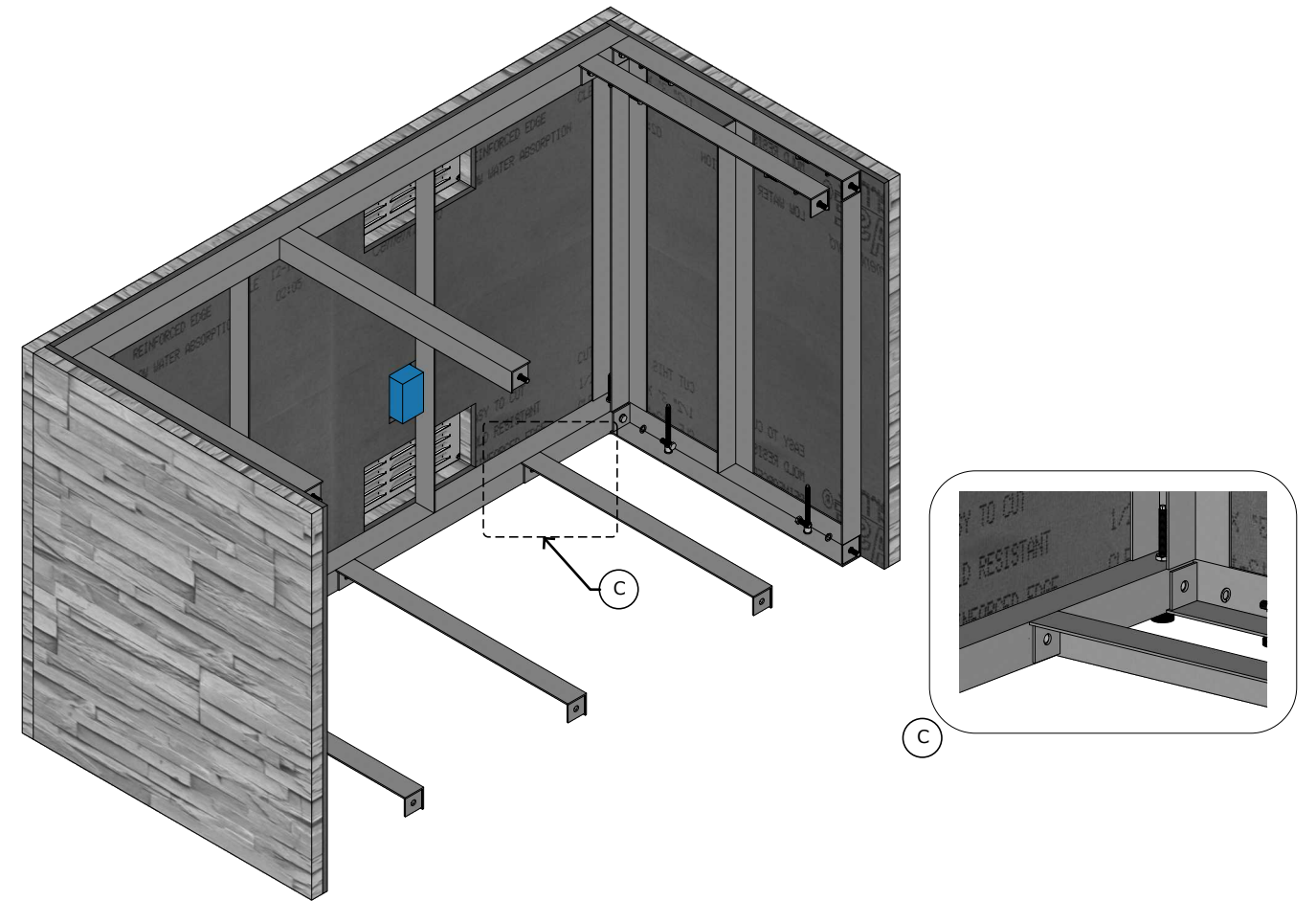

STEP 6
Scale: NTS

MEM-PF-5' ISLAND_INSTRUCTIONS

- LW01
- B01
- ST02
- BTT25

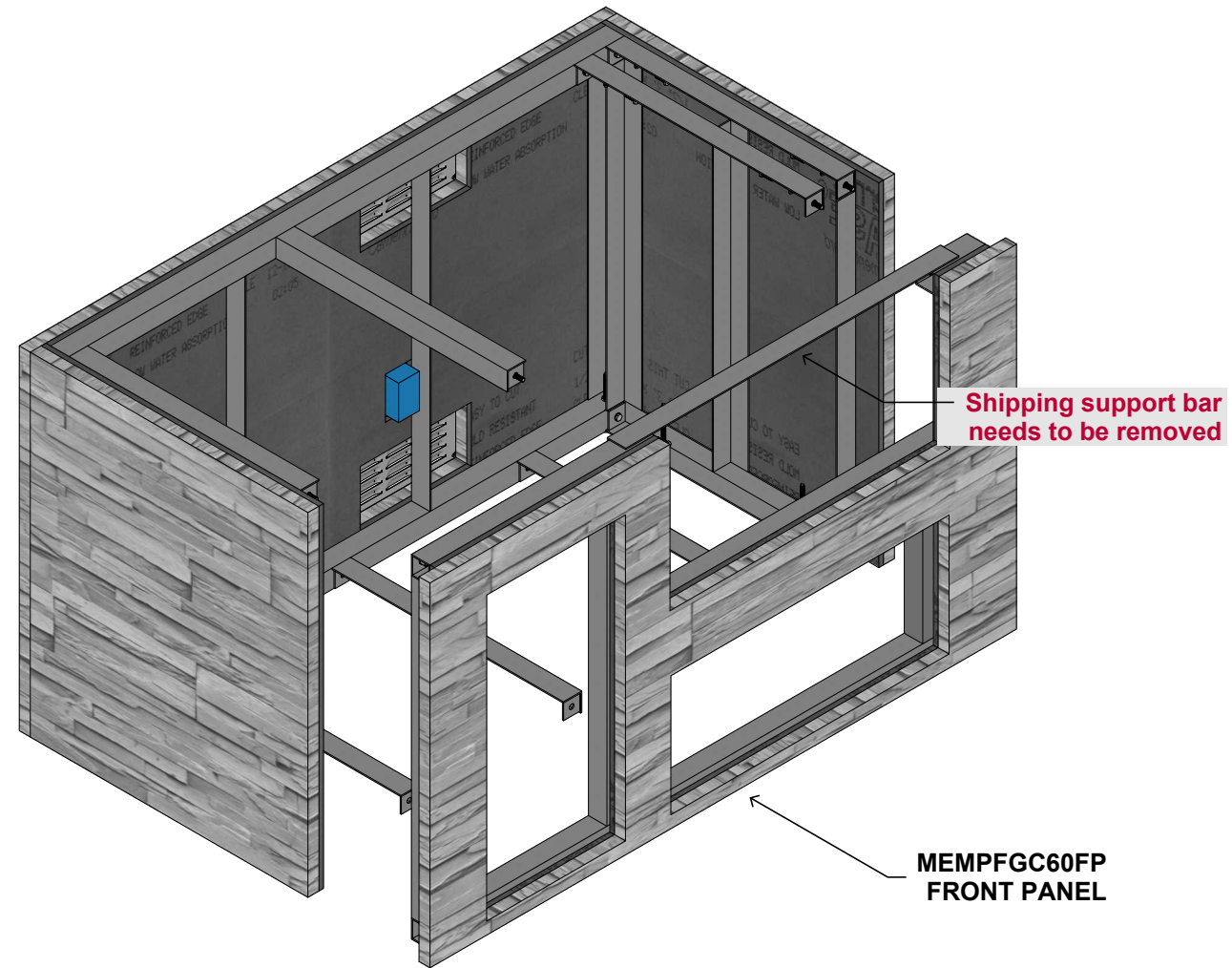

STEP 7
Scale: NTS

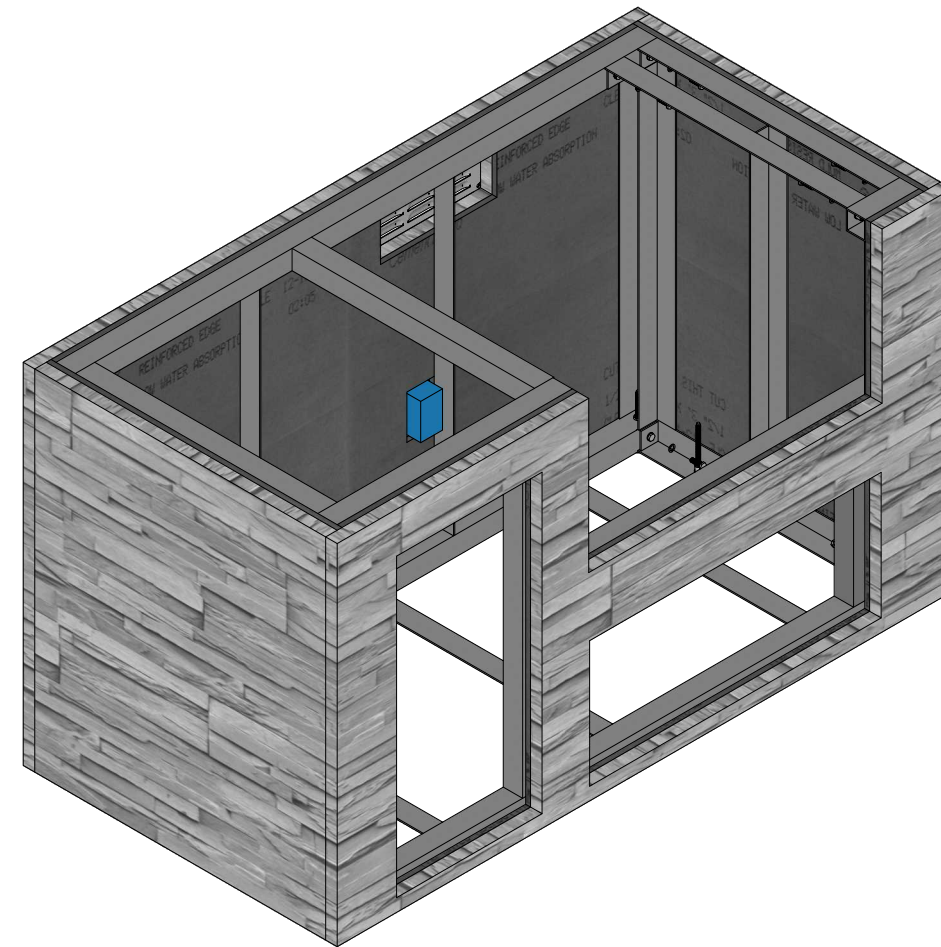

STEP 8
Scale: NTS

MEM-PF-5' ISLAND_INSTRUCTIONS

- LW01
- B01
- ST02
- BTT25

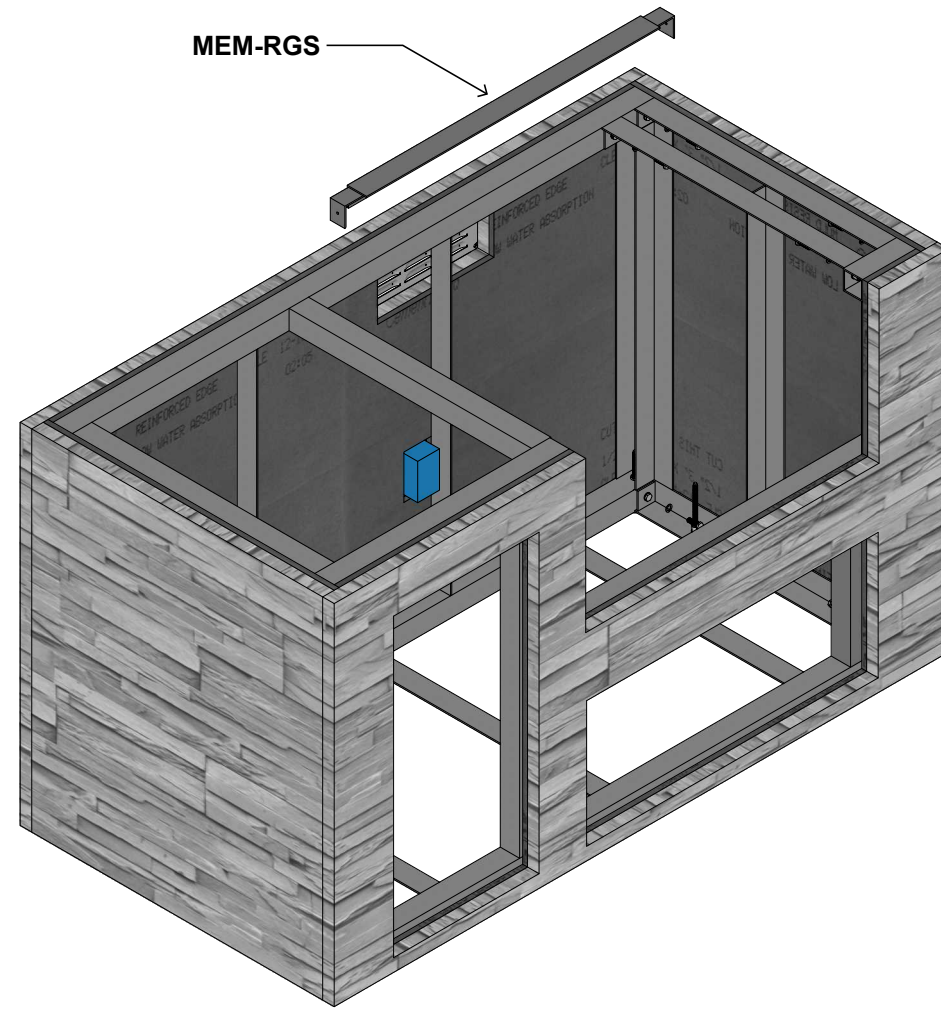



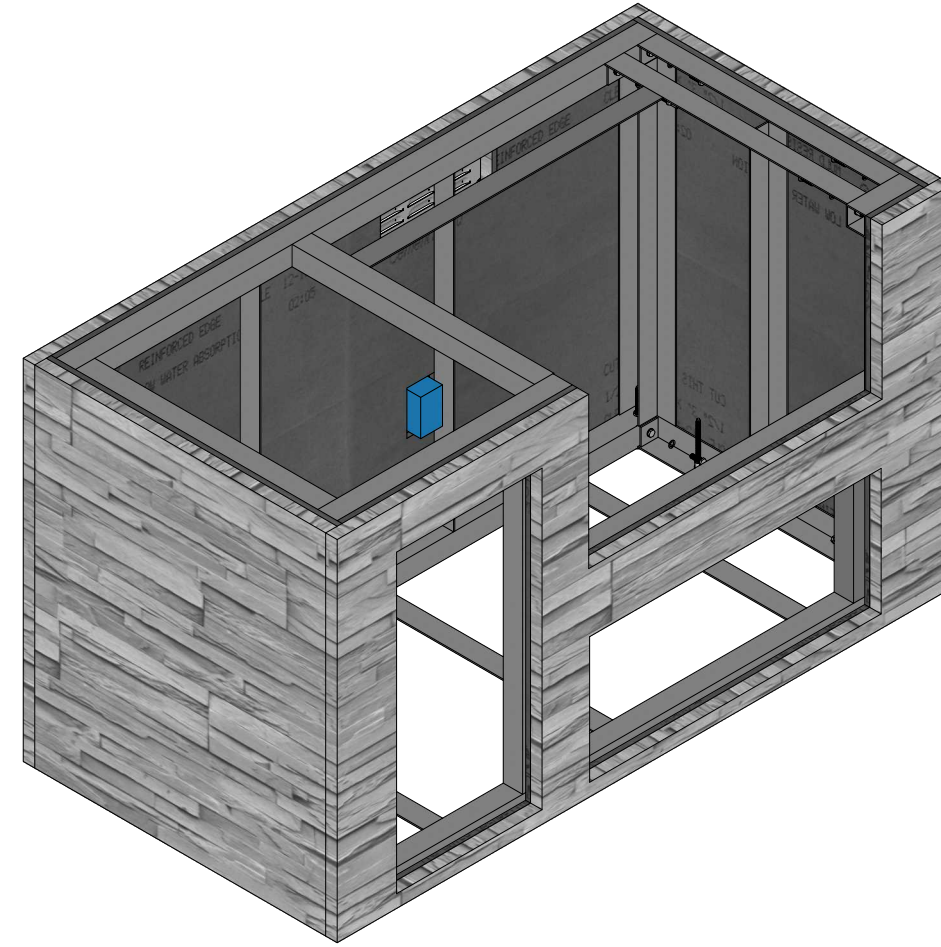

STEP 9
Scale: NTS



STEP 10
Scale: NTS

MEM-PF-5' ISLAND_INSTRUCTIONS

-  LW01
-  B01
-  ST02
-  BTT25

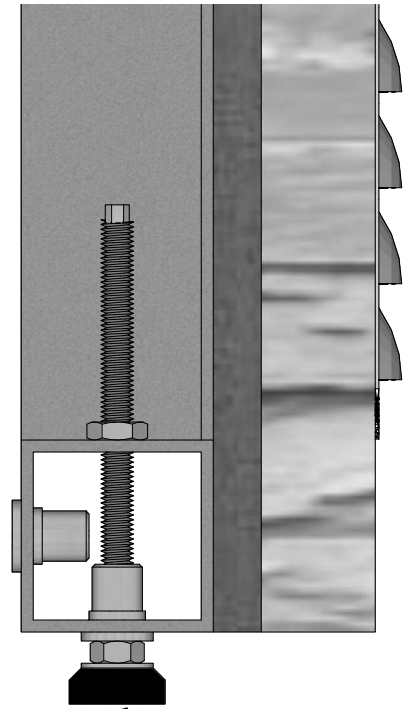

LF LOWER POSITION

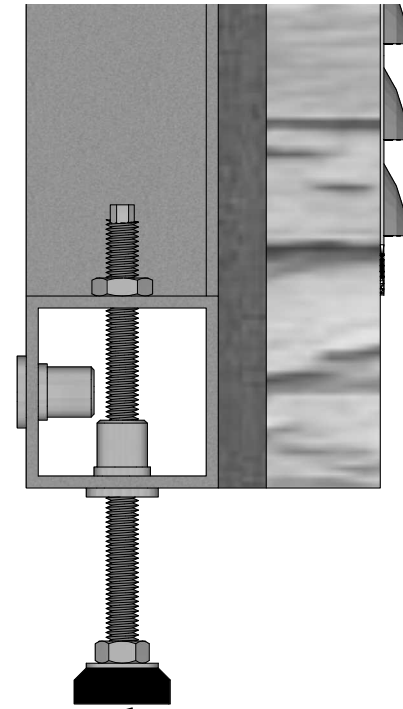

LF CUSTOM HEIGHT POSITION

MEM-PF-5' ISLAND_INSTRUCTIONS

- LW01
- B01
- ST02
- BTT25

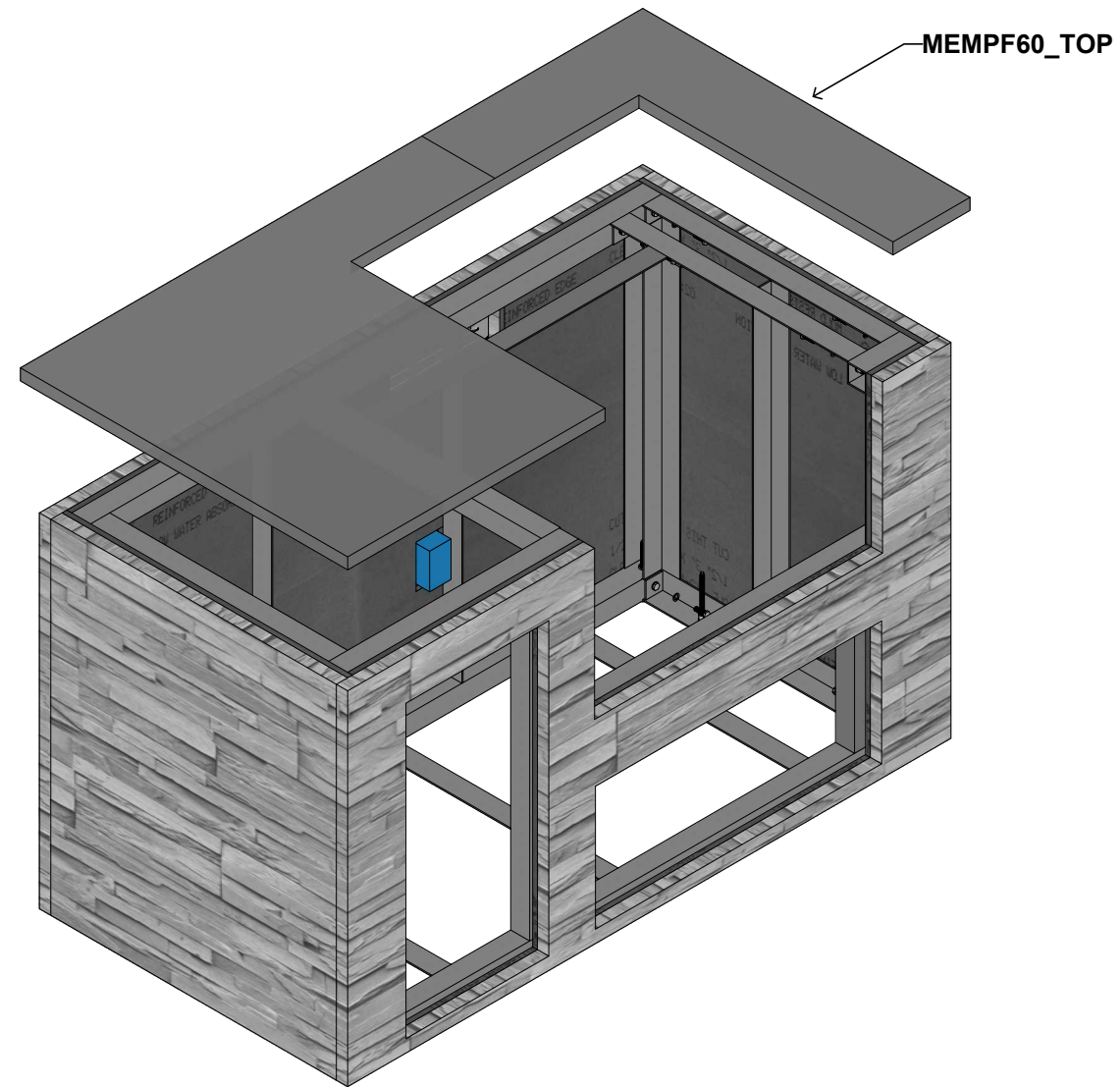



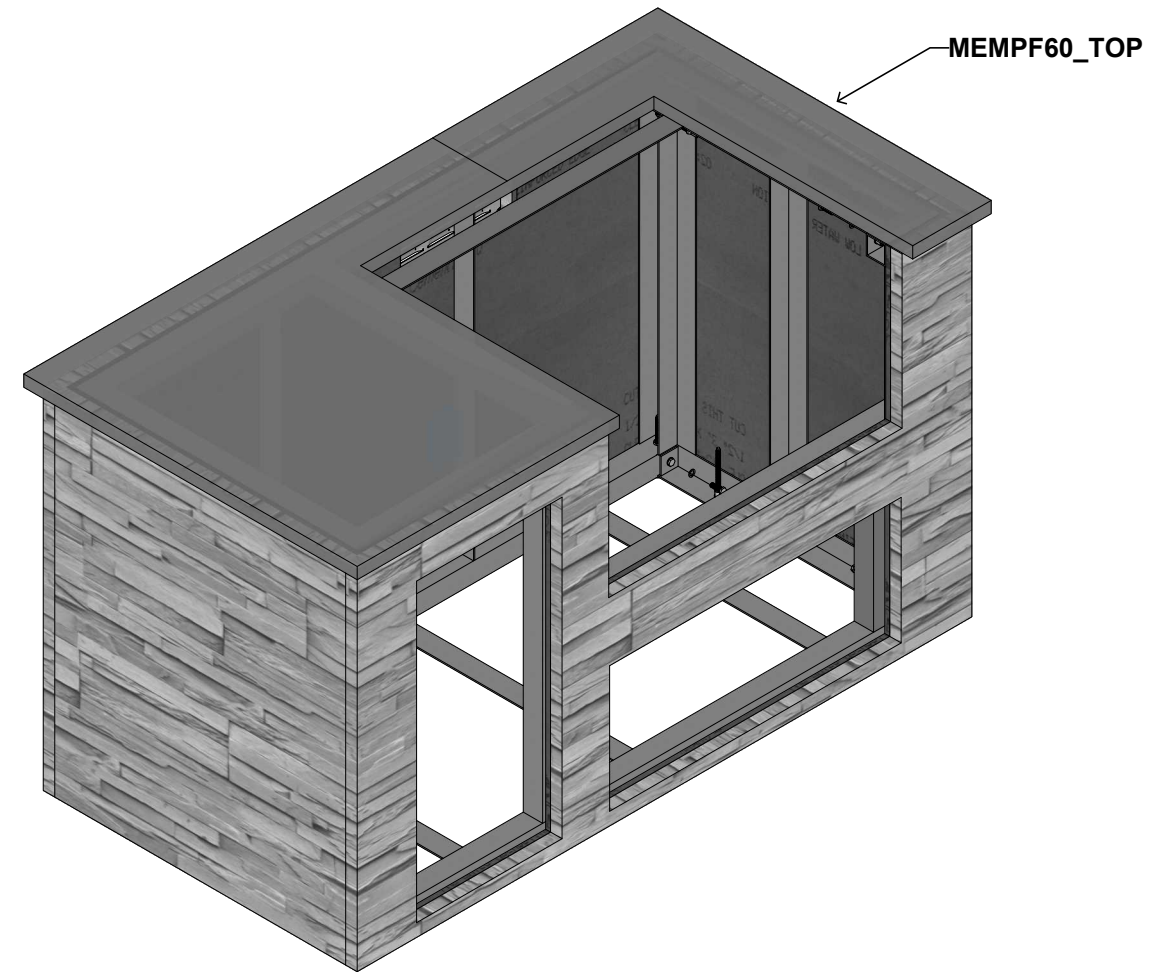

STEP 11
Scale: NTS



STEP 12
Scale: NTS

MEM-PF-5' ISLAND_INSTRUCTIONS

-  LW01
-  B01
-  ST02
-  BTT25

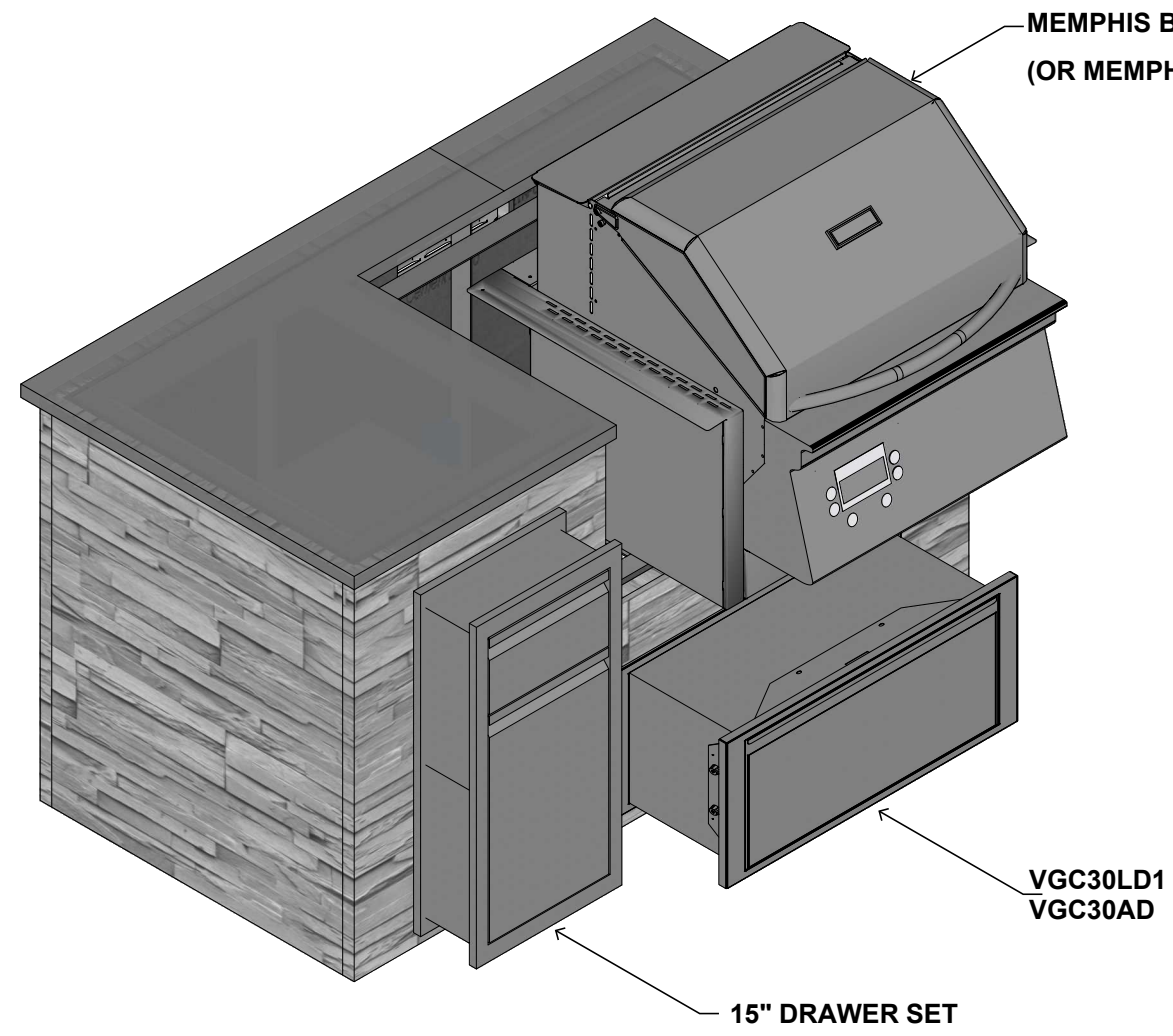

STEP 13
Scale: NTS

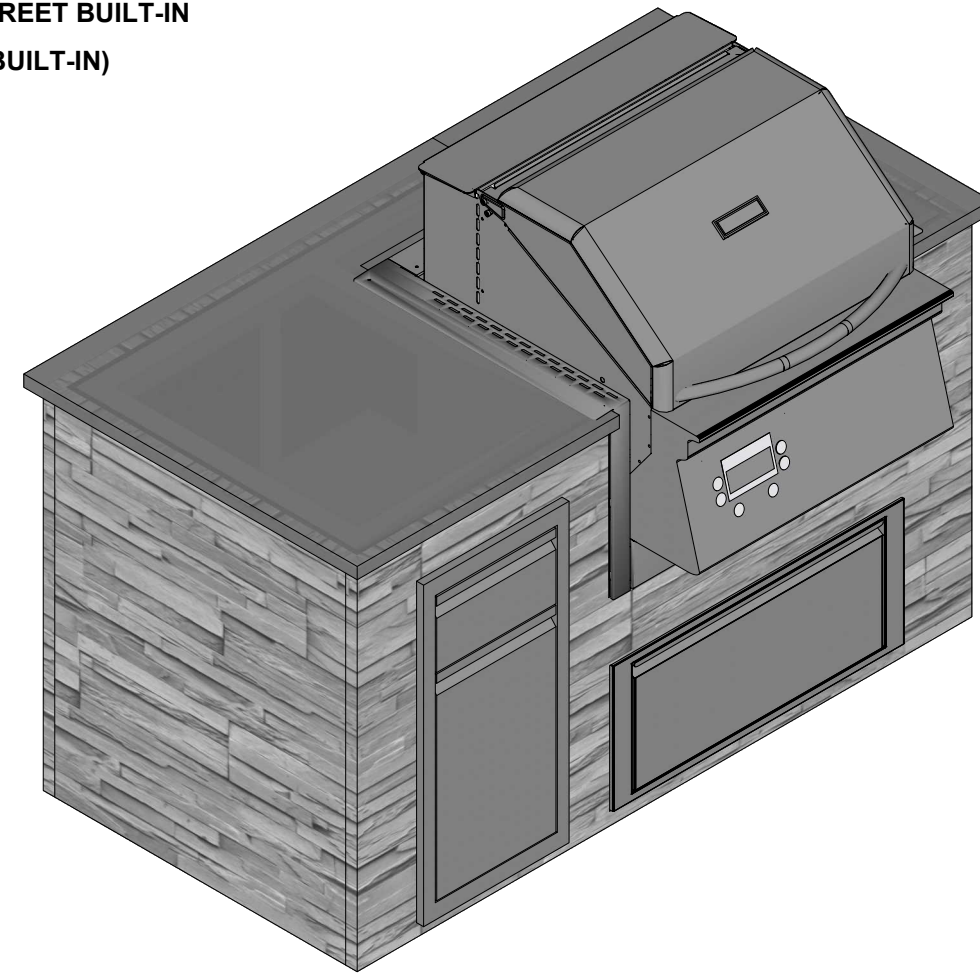

STEP 14
Scale: NTS