

## MEMPHIS WI-FI SET UP GUIDE

### ON YOUR GRILL CONTROLLER:

- 1) A Wi-Fi connection can be set up in minutes on your Memphis Wood Fire Grill. First power the grill on pressing the top left button on the controller, and from the home screen press the "MENU" button, then the "DOWN ARROW", then the "WIFI" button.
- 2) The "WIFI" screen on your grill contains everything needed to connect your grill to a Wi-Fi network. First, you will notice that Wi-Fi is off, this is enabled by default for users not wishing to use Wi-Fi. To turn Wi-Fi on, simply press the button "TURN ON WIFI".
- 3) Next, press and hold "SETUP" and the grill will start searching for all nearby Wi-Fi networks. Once the status field displays "CONNECTING" the grill is ready to be connected to your network via any Wi-Fi compatible device.

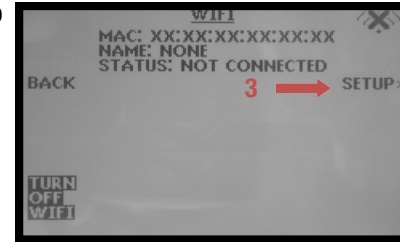
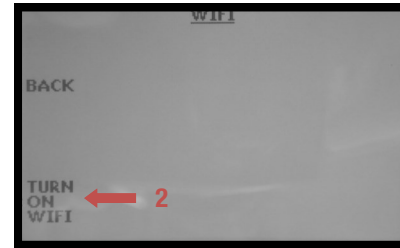

### ON YOUR PHONE OR TABLET: (UNDER WIFI SETTINGS)

- 4) Simply go to available Wi-Fi networks on your phone or tablet and select the network "Memphis Grill xx:xx" **NOTE: The xx:xx characters will be your own unique combination of letters and numbers, and will match the last 4 digits shown on the grill controller next to MAC.**
- 5) Once selected, the network will automatically bring you to a page where all Wi-Fi networks that the grill can connect to can be displayed. Find all connectable networks by hitting search, then once displayed you can click on the network desired and it will auto populate the "SSID" with your selection. If the network does not require a password, leave the password field blank.
- 6) Click "CONNECT" and the page will automatically close.
- 7) The Wi-Fi setup is now complete. The status on the controller should now read "WIFI CONNECTED". The time period from hitting "CONNECT" to "WIFI CONNECTED" can take up to 3 minutes based on connection strength.

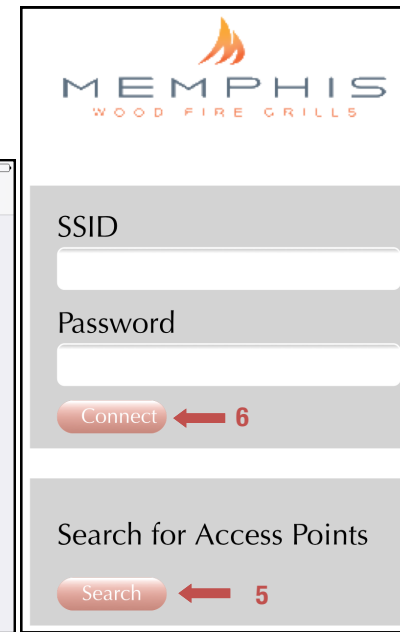
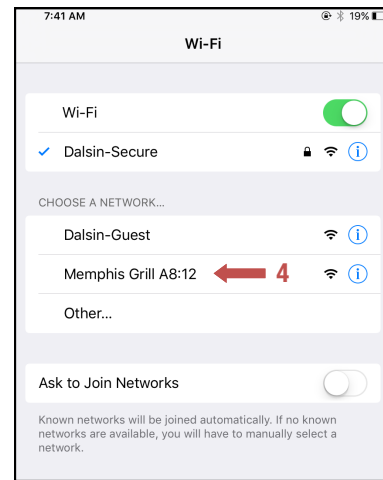

### ON YOUR PHONE OR TABLET: (IN THE MEMPHIS GRILLS APP)

- 8) Download our app MEMPHIS GRILLS from the IOS App Store. (Search iPhone only)
- 9) Enter a valid email into the "CUSTOMER ID" field, and create a password that you will use to login to the app. After logging in, you will receive an email requiring you to confirm your email address before continuing.
- 10) Once the confirmation link is followed from your email, return to the app.
- 11) Once confirmed, you will be able to add your grill. Enter the exact MAC Address and Name shown on the grill controller

**Example:**  
**MAC: F8:F0:05:F4:A8:12      NAME: MEMPHIS**

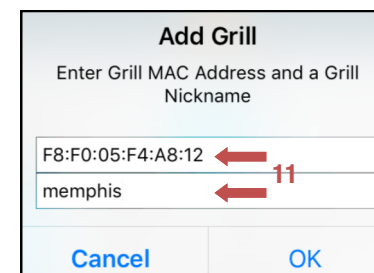

NOTE: THERE ARE ONLY NUMERICAL 0'S IN THE MAC ADDRESS, NO ALPHABETICAL O'S. NICKNAME IS NOT CASE SENSITIVE. INCLUDE COLONS IN THE MAC ADDRESS AS SHOWN.

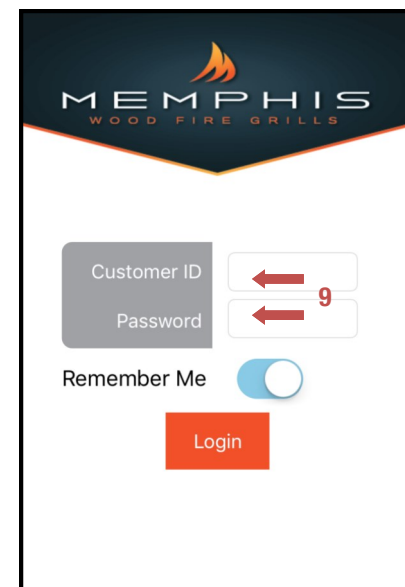

## ELITE QUICKSTART GUIDE



### TOOLS REQUIRED

- 3/8" Open End Wrench, Socket or Adjustable Wrench
- Phillips Screw Driver or Drill
- Snips or Heavy Duty Scissors
- Cut Resistant Gloves

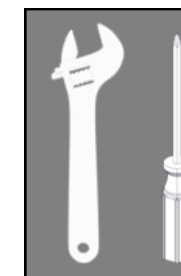

### CONTENTS

- 1: Tools Required
- 2: Included Hardware
- 2-3: Assembly Instructions
- 4: Wi-Fi Setup and App Pairing

### TIME REQUIRED

1.5 Hours

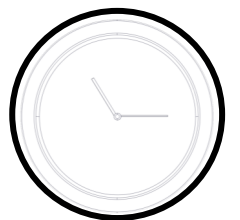

# HARDWARE COMPONENTS

# MEMPHIS ELITE ASSEMBLY INSTRUCTIONS

DESCRIPTION/PART NO.	QTY:	PICTURE
1) Grate Kit VG4401, VG4406	1	
2) Flavorizer VG4403	1	
3) Direct Flame Insert VG4407	1	
4) Genie Tool VG1594	1	
5) Shelf Bolt DS2311	10	
6) Shelf Washer VG0216	9	
7) Antenna VG9025	1	
8) #10 Screw DS2185	2	
9) Cord Wrap VG0560	1	
10) Power Cord VG0911	1	
11) Meat Probe VG0956	1	

1: Remove both shelves, the hardware kit, Flavorizer, and grate kit from the grill. The shelves are located in boxes underneath the grill. The Flavorizer and grate kit are in the grill hood. To remove the Flavorizer, cut the 4 zip ties holding it in place.

Remove all laser film on the grill. This is a peel-able plastic left on to protect your grill from scratches during manufacturing and transit. Remove all laser film and laser etch lines with the included stainless steel wipes, WD40, or olive oil. Once a grill has been heated up it is very difficult to remove this film, be sure to check your grill thoroughly before first burn.

2: Replace the Flavorizer and place 3 large grates on the lower level and the long grate on the upper level.

3: Remove the Direct Flame Insert, Genie Tool, and included pellets from the non-controller side shelf (right).

4: Remove the shelf pan and pan tray from the controller side shelf (left) before installation.

5: Install 5 shelf bolt (#5) and shelf washer (#6) pairs into the right side of the grill. Leave approximately 1/4" of the bolts sticking out so that the shelf can slide onto them.

**NOTE: ALWAYS HOLD SHELVES FROM THE BOTTOM AS THE SHELF TOP FLIPS OPEN!**

6: Slide the shelf onto the bolts, press down on the shelf to secure into the keyway. Tighten bolts using 3/8" wrench, socket, or adjustable wrench.

7: Repeat steps 5 and 6 for the left side of the grill. The left side only requires 4 bolt and washer pairs for this step.

8: Lift the hopper lid. Remove the two screws from the back panel as shown and lift up on the back panel.

9: Route the Ethernet cable connected to the controller side shelf into the back of the grill. The port is located just below the main wiring harness on the controller side of the grill. Tighten the strain relief once you have pulled approximately 3 feet of cord into the grill.

10: Connect the Ethernet cable to the Wi-Fi card located directly above the port on the side of the grill. Note: The tab on the Ethernet cord goes towards the front of the grill.

11: Attach the included antenna to the grill by twisting in a clockwise motion. The antenna will be included in the hardware kit located in the grease tray.

12: Replace the back panel as shown. There are 3 metal tabs on the bottom of the panel that must be slid into place before securing. Reinsert and tighten included screws.

13: Attach the main grill harness to the plug in the back of the grill controller box.

14: Reinsert and fasten the shelf pan and shelf tray as shown using the last shelf bolt included in the hardware kit. Note: This bolt does not get a washer.

15: Attach the cord wrap with included screws found in the hardware kit. Plug in the grill using the included power cord.

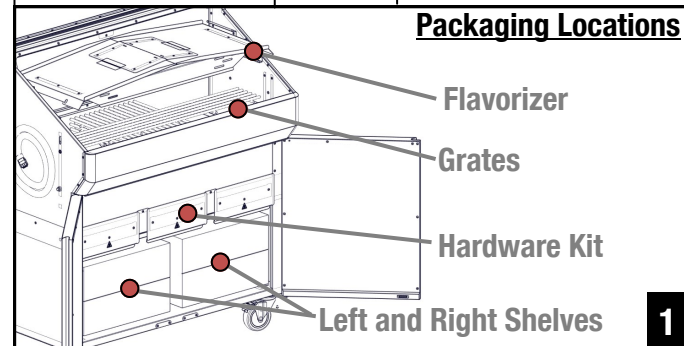

COMPLETE THE STEPS BELOW IN NUMERICAL ORDER, REFERENCE THE SAME NUMBERED DIAGRAM AND HARDWARE COMPONENTS FOR CLARIFICATION.

